

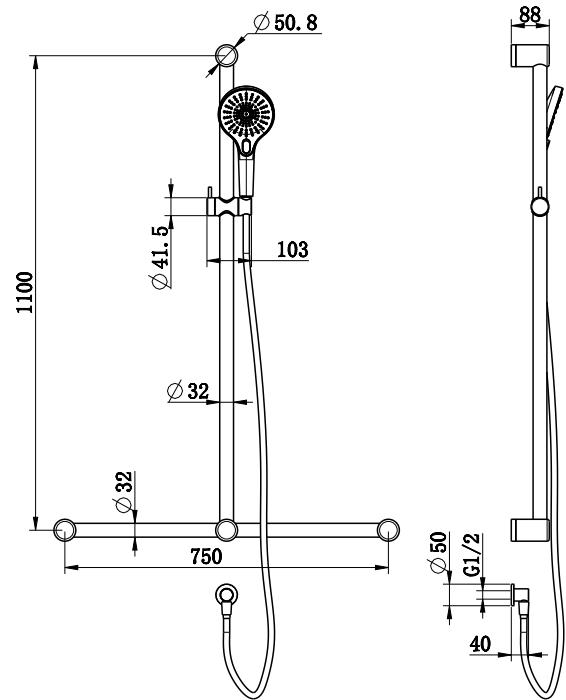





## Mecca Care 32MM Bar Grab Rail And Adjustable Shower Rail Set



### SKU

	CHROME NRCS006CH		MATTE BLACK NRCS006MB
	BRUSHED NICKEL NRCS006BN		GUN METAL NRCS006GM
	BRUSHED GOLD NRCS006BG		BRUSHED BRONZE NRCS006BZ

### WARNING:

These rails are designed to be mounted onto wall studs or masonry walls. Installation is recommended to be completed by qualified trades person who complies with the AS 1428.1-2009 design for access and mobility standard.

It is recommended rail location is determined by a qualified occupational therapist or trained professional to the AS 1428.1-2009 standard. Correct installation is required to ensure safe, long term operation. Incorrect mounting can result in reduced capacity of the rail which can result in injury to user and damage to the wall.

### Features

1. Australian owned and designed.
2. 1.5m PVC hose.
3. The rail can be shortened during installation to suit your bathroom.
4. 150kg capacity for all 25mm and 32mm diameter grab rails.
5. 32mm diameter rails are approved for standard AS1428.1 requirements in DDA bathrooms.
6. Gun metal, brushed gold and brushed bronze colours are PVD coated for long term durability.
7. WELS rating is 3 STAR 9L/MIN.
8. WATERMARK license is WM-060093.



MECCA CARE  
DDA CARE 32MM



1. Put teflon tape onto outlet thread.

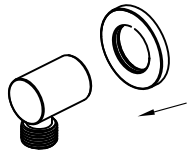

2. Slide plate onto elbow.

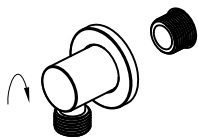

3. Screw elbow onto outlet.

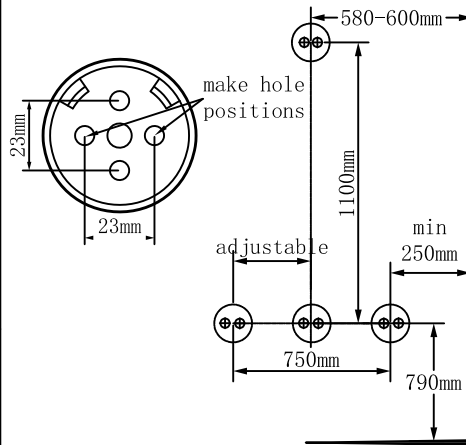

4. Locate wall studs, install into at least one stud.  
Place wall seal/mounting bracket on wall at correct height over centre of stud and mark hole positions on wall refer to above picture.  
Tip: Rail height is 790mm above the ground.

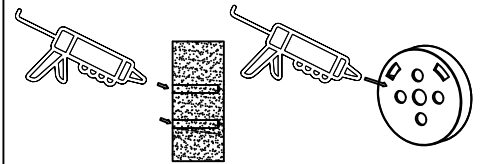

6. Apply small amount of silicon to mounting bracket and wall in and around the screw holes.

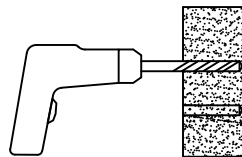

5. Drill pilot holes into wall stud approximately 60mm deep to suit mounting screws (and wall plugs if required).  
wall plugs

Tip: 3mm hole for screws into timber or 8mm hole for wall plugs.

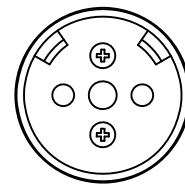

7. Install mounting brackets by screwing onto wall.

Tip: Use appropriate mounting screws for the wall stud material, supplied screws are for timber wall studs.

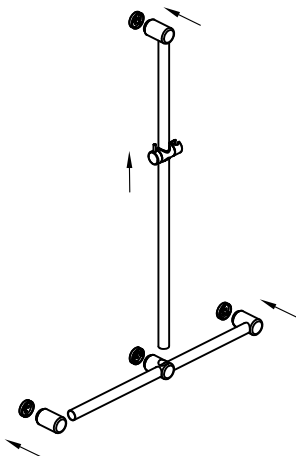

8. Slide the shower slider onto rail, then slide rail tubes into end brackets and push onto wall brackets, refer to above picture.

Tip: Horizontal rail or vertical rail can be cut down to a smaller size, simply use an angle grinder, hacksaw or pipe cutter then deburr the end with a file or grinder and reinsert into the end bracket.

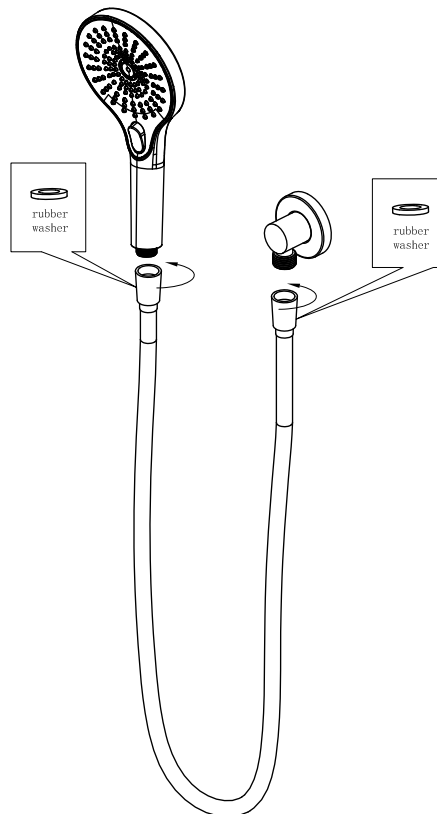

10. Connect hand shower and elbow by shower hose.

Tip: There are two rubber washer in the shower hose.

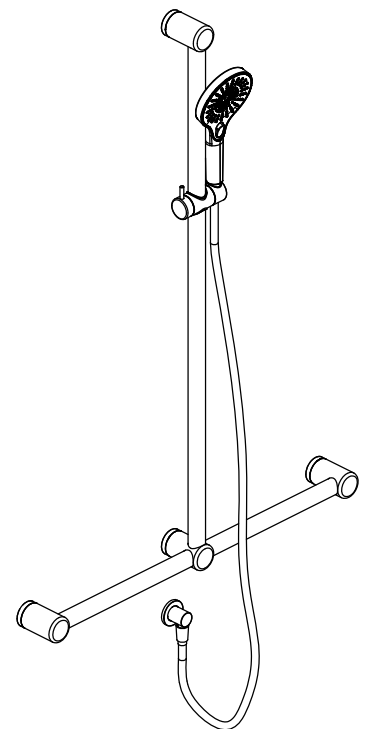

11. Test and check for leaks.

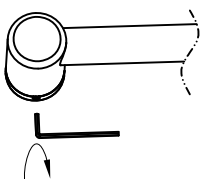

9. Tighten grub screws with allen key.

Tip: If rail rattles, loosen end bracket, twist slightly and tighten.